

These dimensions will be especially checked at delivery
 Only inspection dimensions
 With /E marked dimensions are only valid for internal use

Diese Maße werden bei Abnahme besonders geprüft
 Ausschließlich Prüfmaße
 Mit /E gekennzeichnete Maße sind nur für interne Zwecke gültig

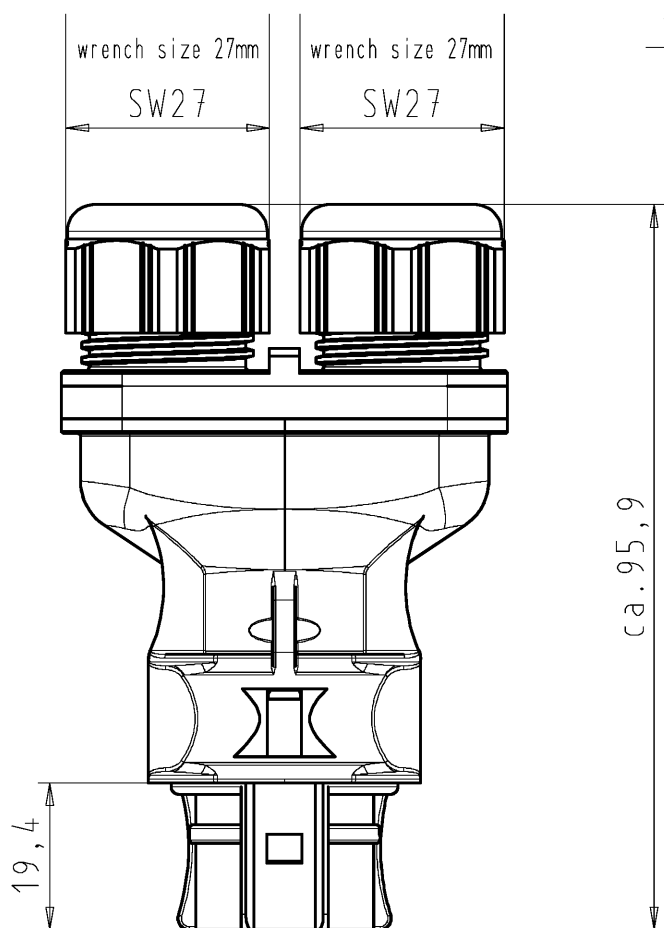

for cable diameter 10-14mm
 für Kabeldurchm. 10-14mm

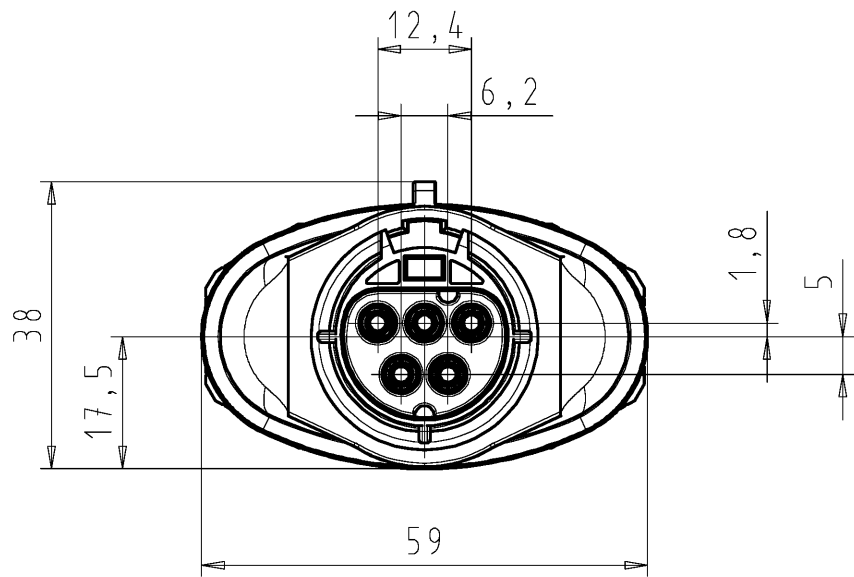
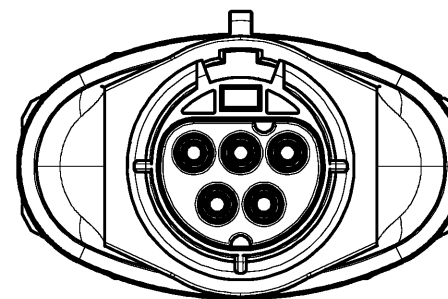

A-A

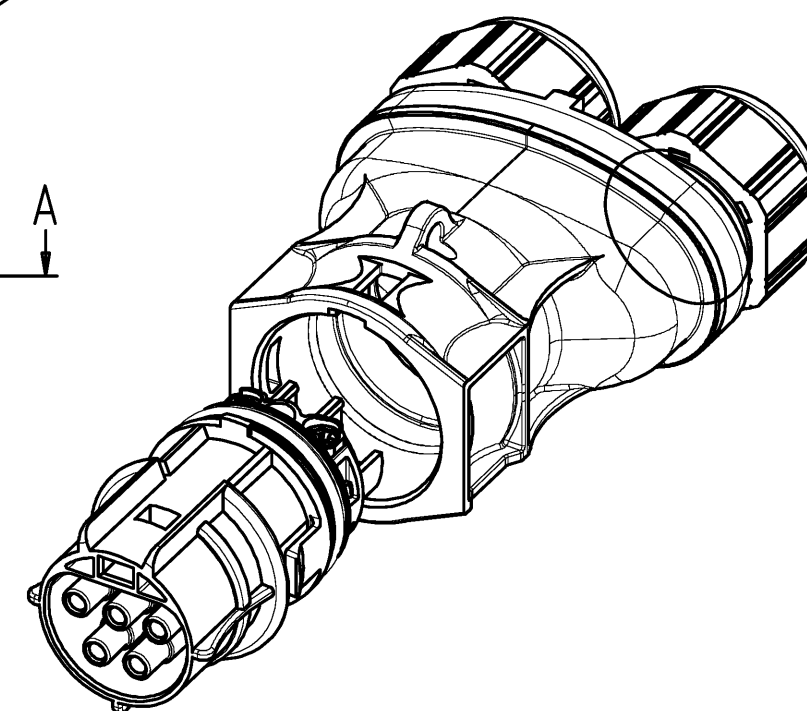
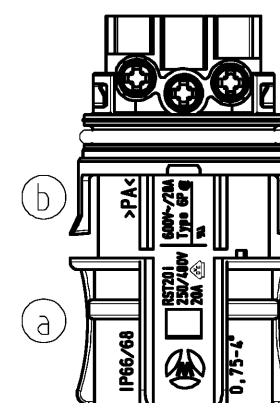
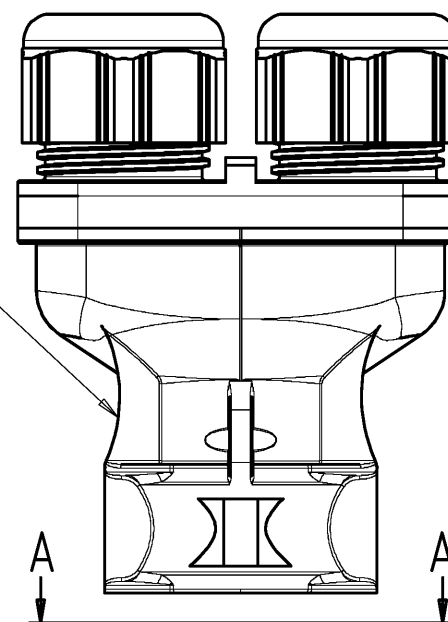
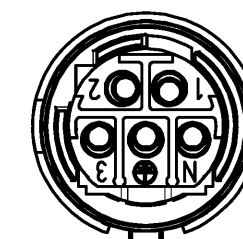

Verpackungseinheit: je 100 Stück
 packaging unit: per 100

Teile-Nr./ part-nr.	Farbe:/ color:	Type
96.051.4353.1	schwarz, ähnl. RAL 9005/ black, similar to RAL 9005	RST2015S B1 ZRY V SW
96.051.4353.0	lichtgrau, ähnl. RAL 7035/ lightgrey, similar to RAL 7035	RST2015S B1 ZRY V GL

Tolerierung Size ISO 14405 (E)/Tolerance system Size ISO 14405 (E). (This ISO-standard describes the envelope principle. According to the envelope principle the deviations of form and parallelism are limited by the size tolerances).		nein/no <input checked="" type="checkbox"/> Stoffverbots- und Deklarationsliste nach WN 5020.010 ist einzuhalten. Conformity with Wieland document WN 5020.010 e (list of prohibited / declarable hazardous substances) to be declared!	
Freitoleranz nach General tolerance	CAD - Zeichnung, keine manuellen Änderungen CAD - drawing, no manual modifications allowed	1. Verwendung: First Use:	Blatt: 1 von 1 Sheet: of 1
Maßstab/Scale 1:1	Werkstoff/Material	2006 Tag/Date Name	Zeichnung Nr./Drawing No. T 96.051.4353.0 01K b
Vol. mm ³ Of l./Surf. mm ²	2006 gezeichnet drawn geprüft checked Normgepr. Stand. check	03.04. Kneitz	
b 15.12.2014/ a 27.01.2011/ Index Datum / Blatt Date / Sheet	Änderung/Revision	Ersatz für/Replacement for: -	
www.wieland-electric.com		Type siehe Tabelle	Benennung/Title BUCHSENTE IL_M_DOPPELZUGENTL female connector with double cord grip Schraubanschluß ohne Drahtschutz/screw-connection without wire protection Standardkodierung 0/standard-keying 0 (250V/400V/20A)

Weitergabe sowie Vervielfältigung dieses Dokuments, Verwertung und Mitteilung seines Inhalts sind verboten, soweit nicht ausdrücklich gestattet.
 The reproduction, distribution and utilization of this document as well as the communication of its contents to others without express authorization is prohibited.